

# GCSE Maths – Geometry and Measures

## Rotation, Reflection, Translation, and Enlargement

### Worksheet

NOTES



SOLUTIONS



This worksheet will show you how to work through rotations, reflections, translations, and enlargements. Each section contains a **worked example**, a **question with hints** and then **questions for you to work through** on your own.

This work by [PMT Education](https://www.pmt.education) is licensed under [CC BY-NC-ND 4.0](https://creativecommons.org/licenses/by-nc-nd/4.0/)



## Section A - Reflection

### Worked Example

Reflect the following shape in the line  $x = 0$

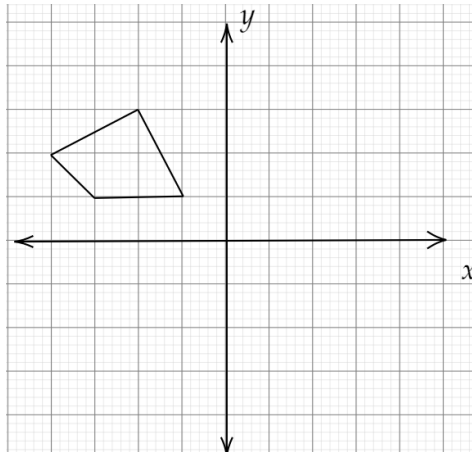

**Step 1:** Find the line in which the shape is being reflected, label all the points on the shape and find the distance from these points to the mirror line.

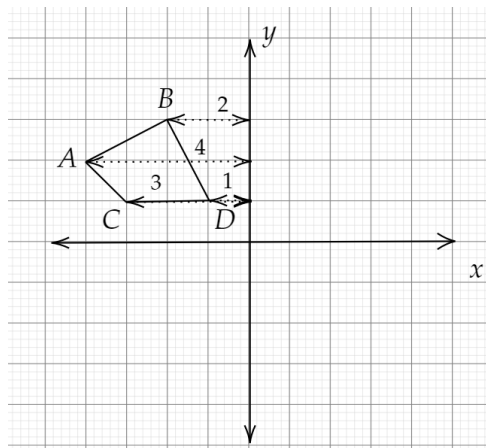

**Step 2:** Mark the same distance on the other side of the mirror line and plot all the points of the image. Join these points to make the final image.

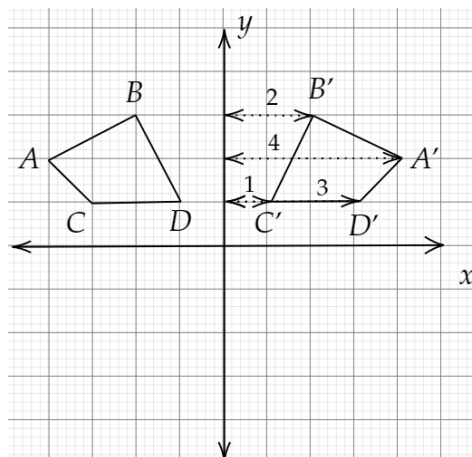

## Guided Example

Reflect the following shape in the line  $y = 3$ . Each square in the grid is of length 1.

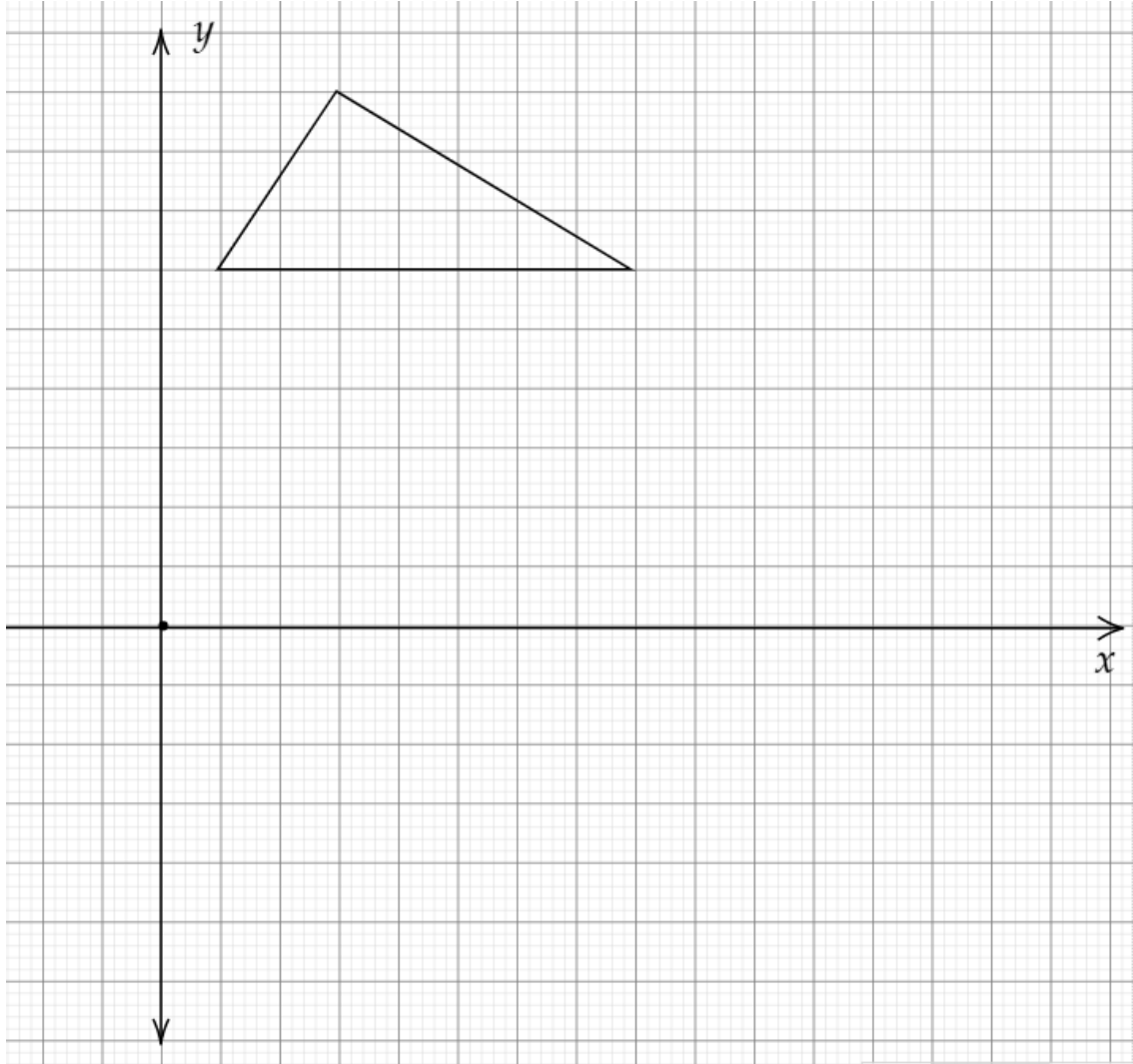

**Step 1:** Find the line in which the shape is being reflected, label all the points on the shape and find the distance from these points to the mirror line.

**Step 2:** Mark the same distance on the other side of the mirror line and plot all the points of the image. Join these points to make the final image.



### Now it's your turn!

If you get stuck, look back at the worked and guided examples.

1. Each square in the grid is of length 1.
- a) Reflect the following shape in the line  $x = 7$

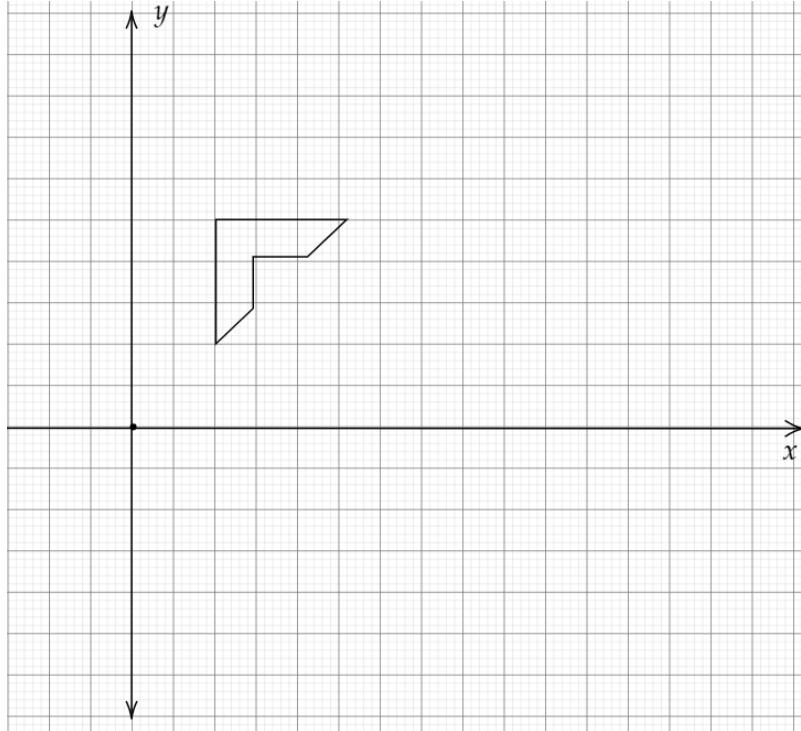

- b) Reflect the following shape in the line  $y = x$

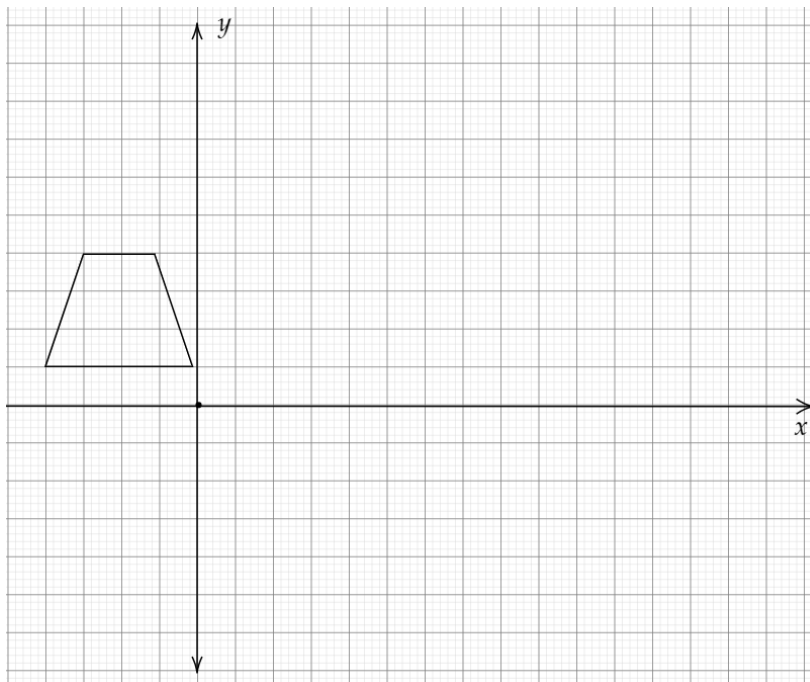

c) Reflect the following shape in the line  $x = -3$ .

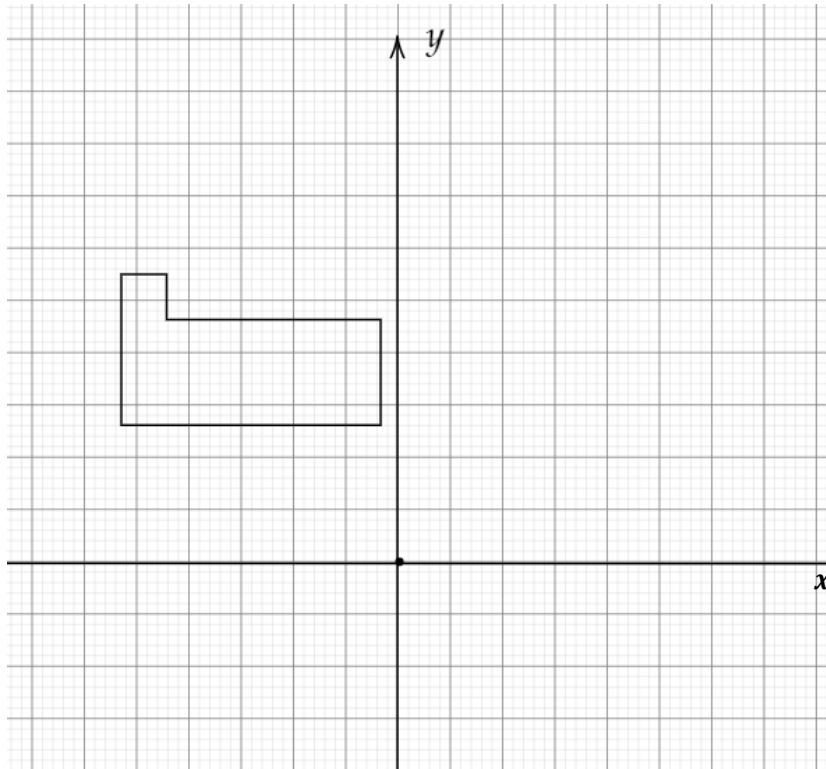

d) Reflect the following shape in the line  $y = x - 1$

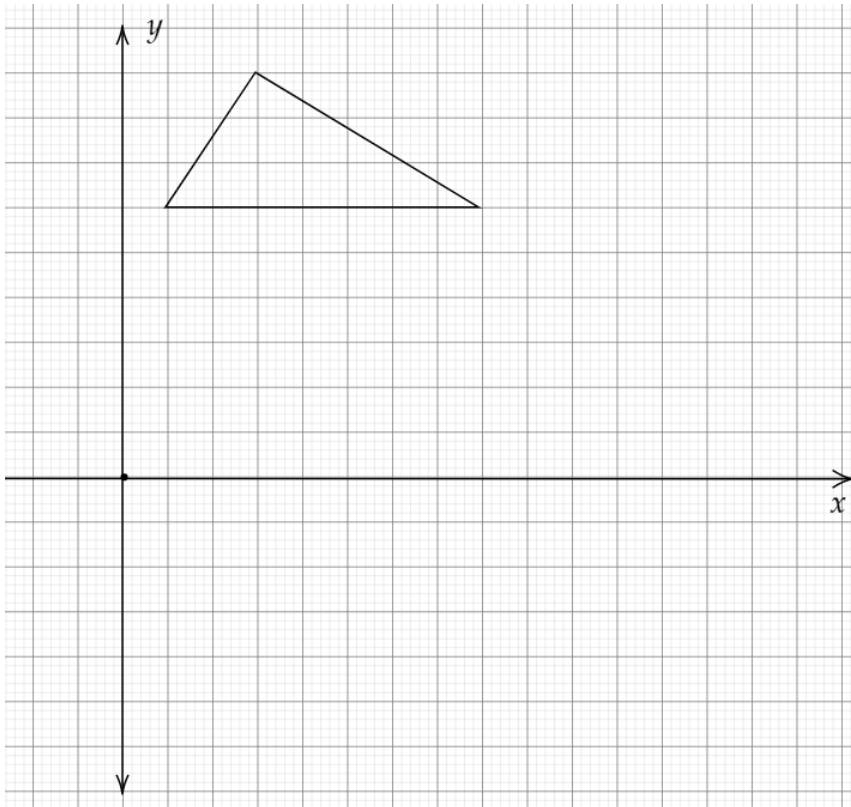

## Section B - Translation

### Worked Example

Translate the following shape by the vector  $\begin{pmatrix} 3 \\ -2 \end{pmatrix}$ . Each square in the grid is of length 1.

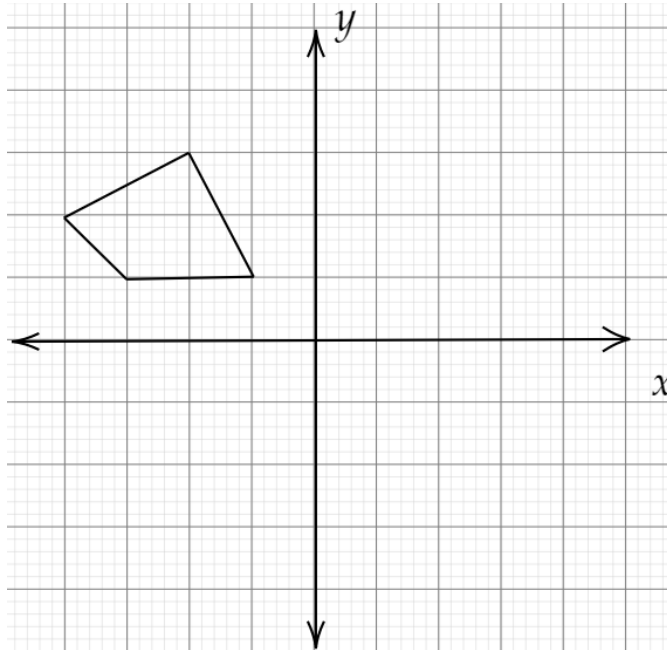

**Step 1:** Identify what the vector means. Write in terms of directions and magnitude what the vector defines.

The above vector  $\begin{pmatrix} 3 \\ -2 \end{pmatrix}$  represents: 'Move 3 squares to the right and 2 squares down'

**Step 2:** Translate all the points of the shape using the vector.

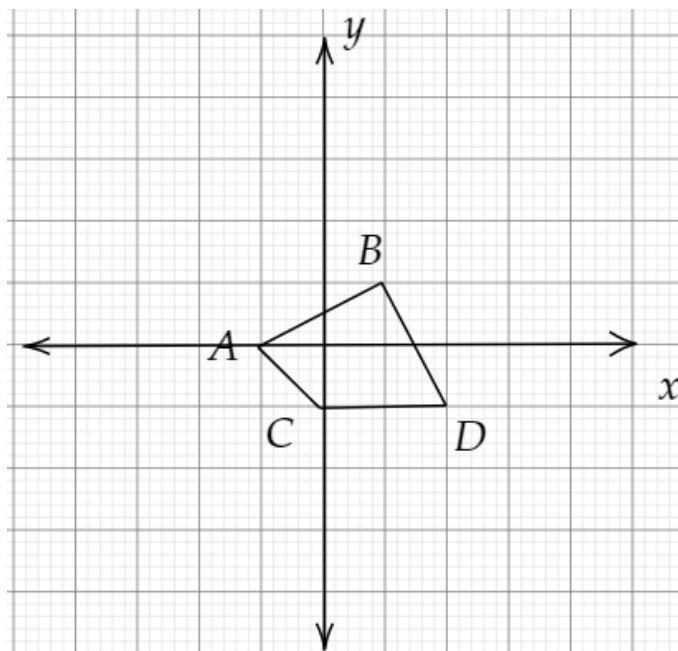

### Guided Example

Translate the following shape by the vector  $\begin{pmatrix} -4 \\ -1 \end{pmatrix}$ . Each square in the grid is of length 1.

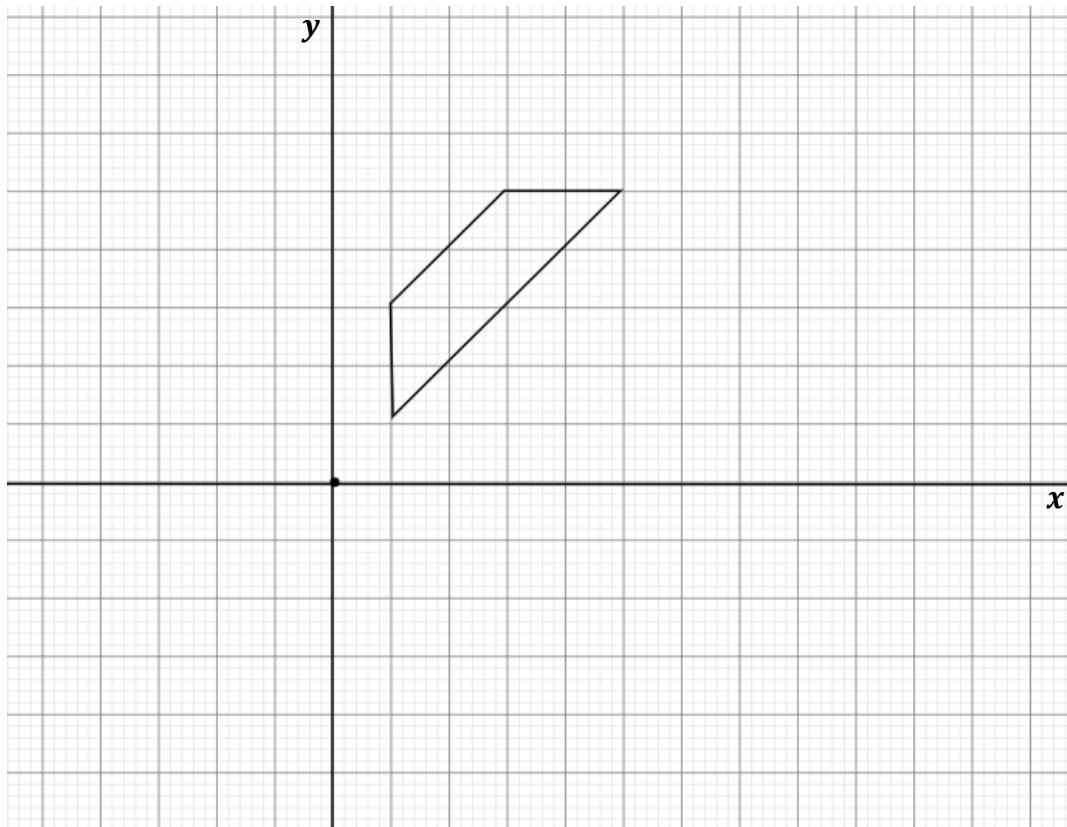

**Step 1:** Identify what the vector means. Write in terms of directions and magnitude what the vector defines.

**Step 2:** Translate all the points of the shape using the vector.



## Now it's your turn!

If you get stuck, look back at the worked and guided examples.

Each square in the grid is of length 1.

2. The following graph shows two shapes labelled A and B.
  - a) Work out the vector that translates shape A to shape B.
  - b) Work out the vector that translates shape B to shape A.

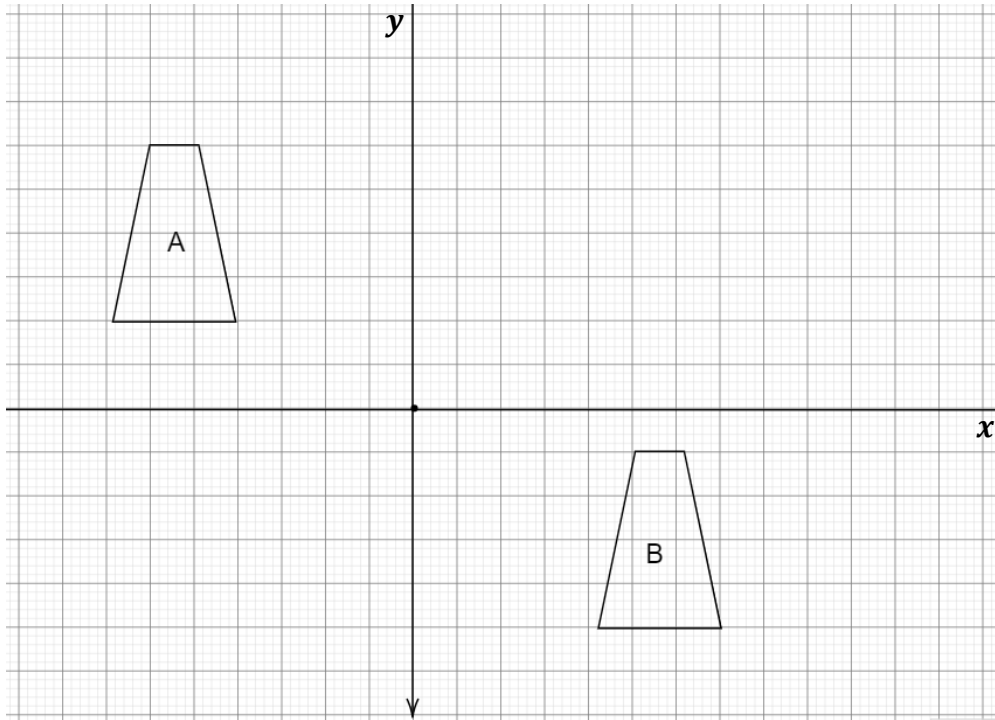

3. Translate the following shape by the vector  $\begin{pmatrix} 4 \\ -4 \end{pmatrix}$ .

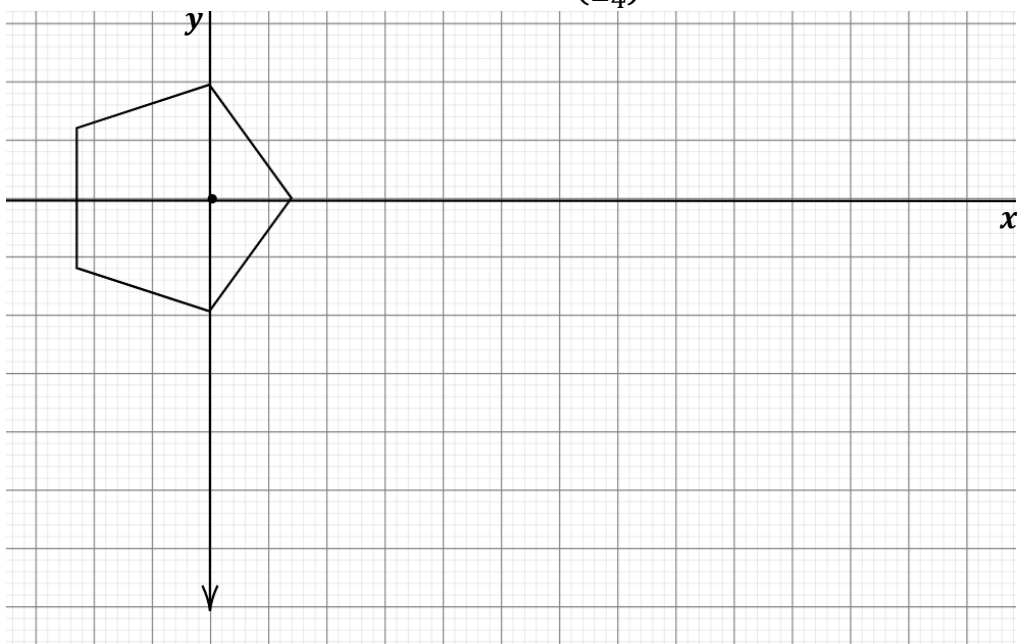



4. The following grid shows two shapes labelled A and B.

a) What vector transforms shape A to shape B?

b) Translate shape B by the vector  $\begin{pmatrix} -1 \\ -2 \end{pmatrix}$ .

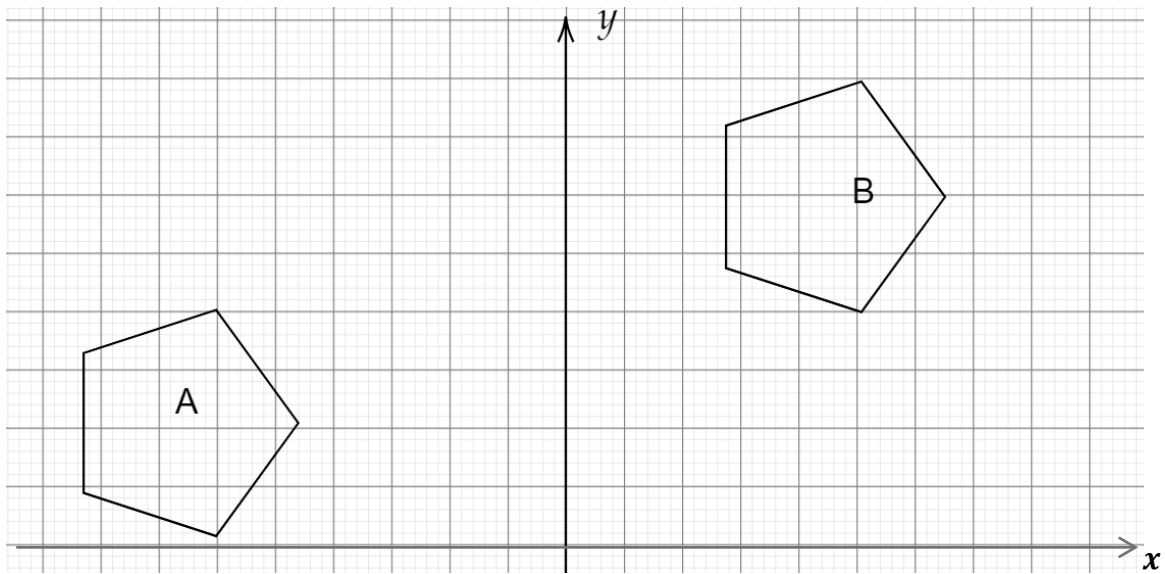

## Section C - Enlargement

### Worked Example

Enlarge the following shape by a scale factor of three with the origin as the centre of enlargement.

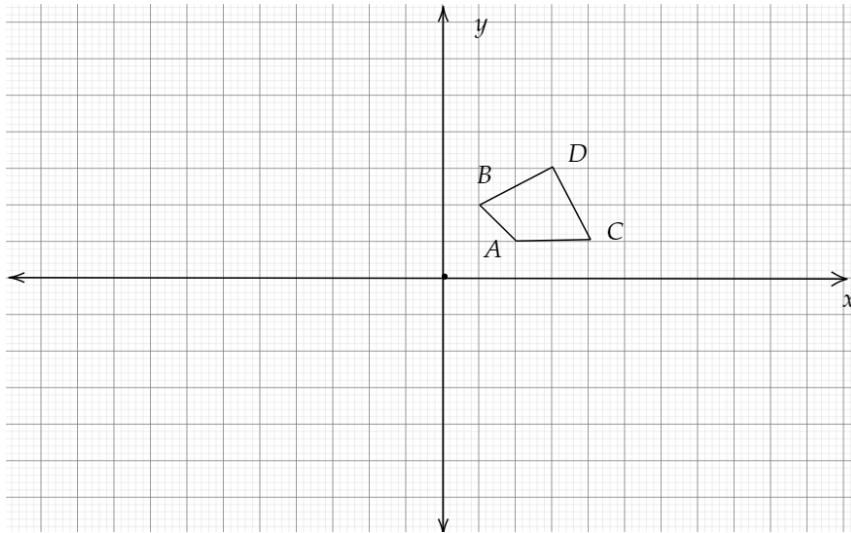

**Step 1:** Choose an appropriate initial point to enlarge. Find the horizontal and vertical distance from this point to the centre of enlargement.

*We will choose point A because it is closest to the centre and so easier to solve through.*

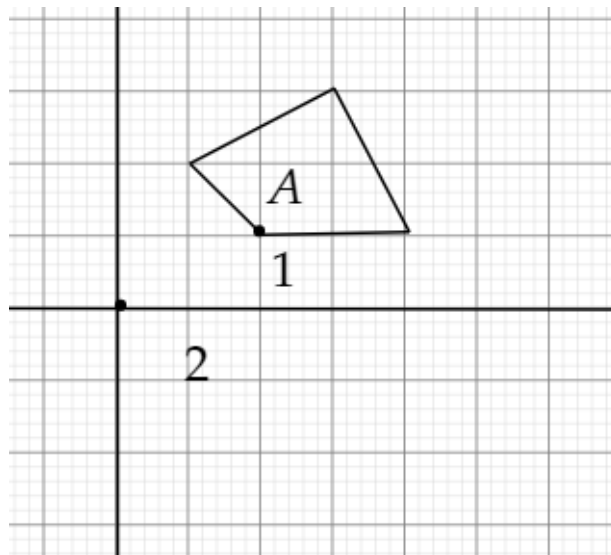

**Step 2:** Multiply the distances found by the scale factor.

*Scale factor = 3*

*New horizontal distance = Original horizontal distance  $\times$  3 =  $2 \times 3 = 6$*

*New vertical distance = Original vertical distance  $\times$  3 =  $1 \times 3 = 3$*



**Step 3:** Use the new distances found to find the image of the point chosen.

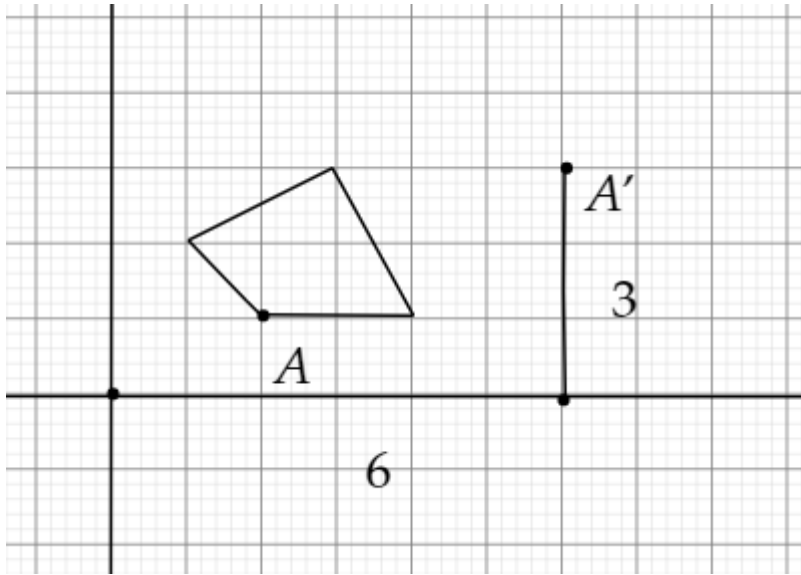

**Step 4:** Work out the final whole enlarged shape.

*Each side is going to be 3 times bigger. We can find AC this way.*

*For the diagonals, we find vertical and horizontal distance and times them by 3.*

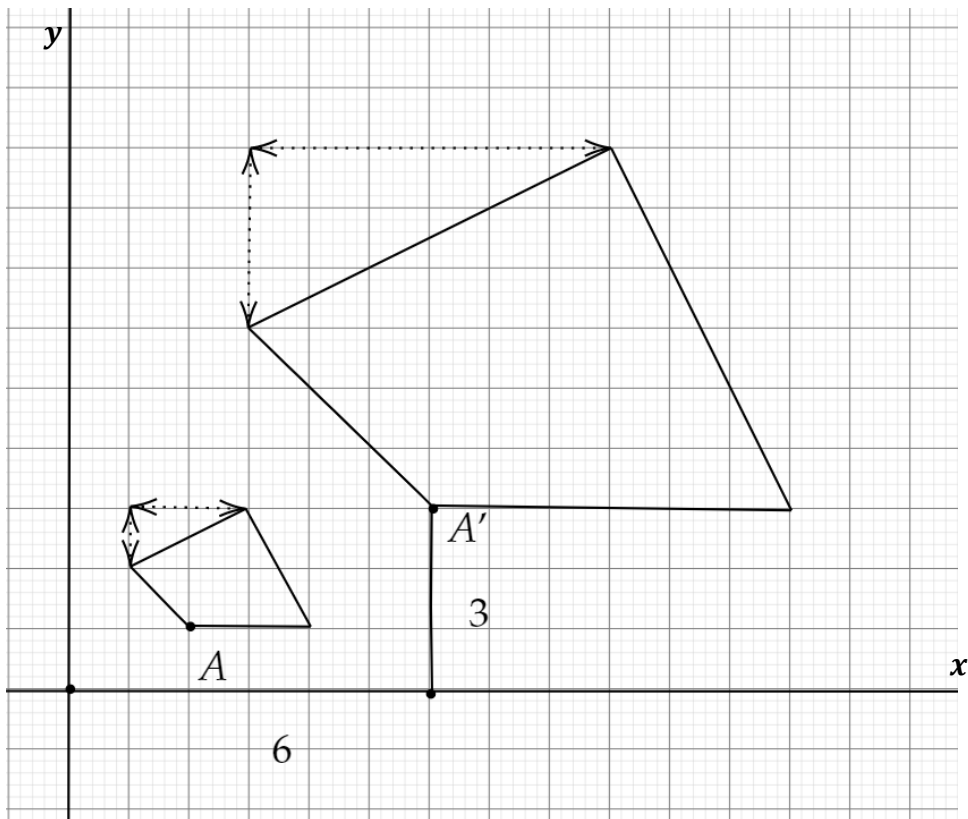

## Worked Example

Describe fully the transformation that mapped shaped A to B.

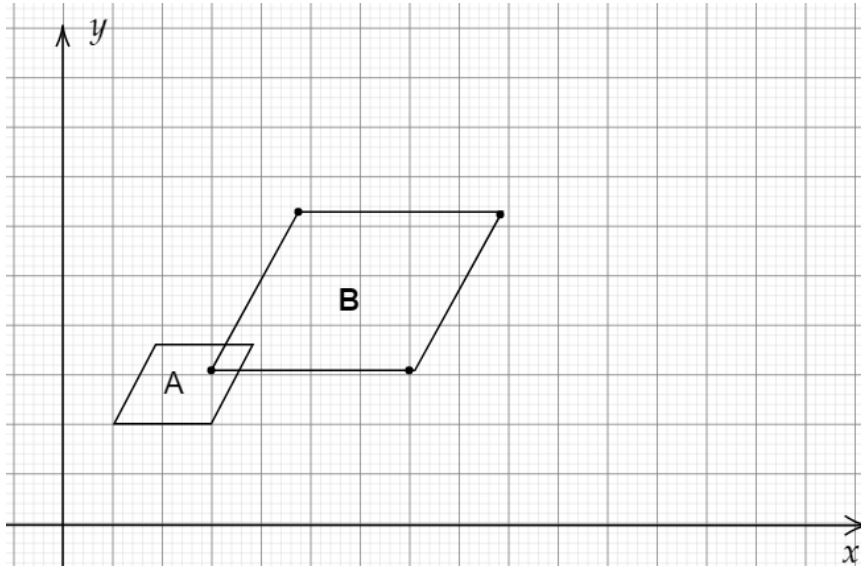

**Step 1:** Join all the corresponding points on both the shapes. Elongate these lines and find where they meet. This is the centre of enlargement.

*The centre of enlargement is  $(-1, 1)$ .*

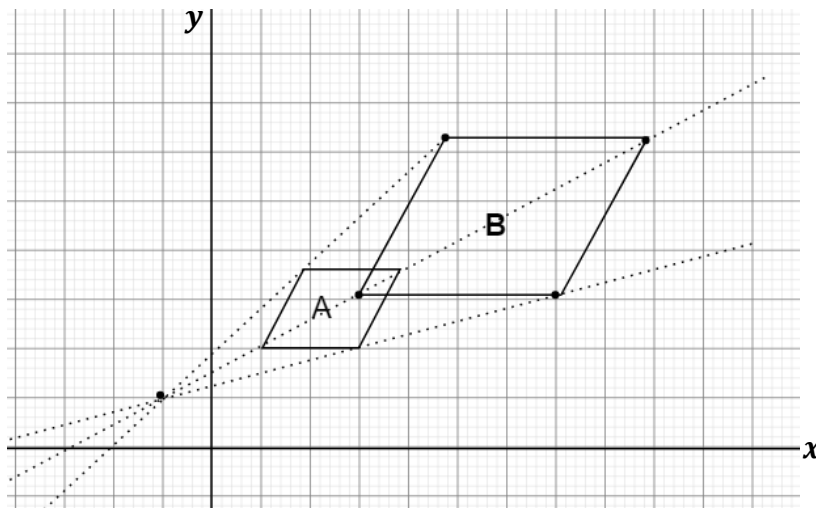

**Step 2:** Find the scale factor.

*Each side length is doubled. Therefore, the scale factor is 2.*

**Step 3:** Describe the transformation.

**Enlargement:**

- **Centre of enlargement**  $(-1, 1)$
- **Scale factor** 2



## Guided Example

Enlarge the following shape by a scale factor of 2 with the centre being  $(2, 3)$ .

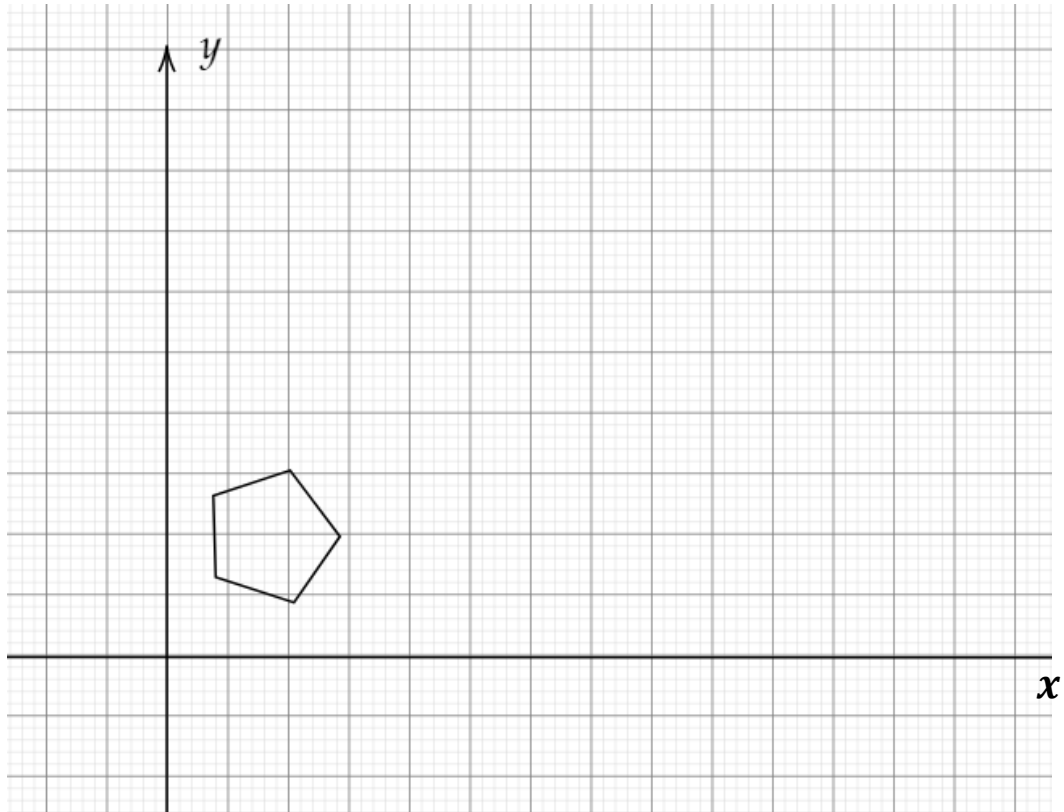

**Step 1:** Plot the point for the centre of enlargement.

**Step 2:** Choose an appropriate initial point to enlarge. Find the horizontal and vertical distance from this point to the centre of enlargement.

**Step 3:** Multiply the distances found by the scale factor.

**Step 4:** Use the vector found to find the image of the point chosen.

**Step 5:** Work out the final whole enlarged shape.



## Guided Example

Enlarge the following shape by a scale factor of  $\frac{1}{2}$  with the centre being  $(2, 2)$ .

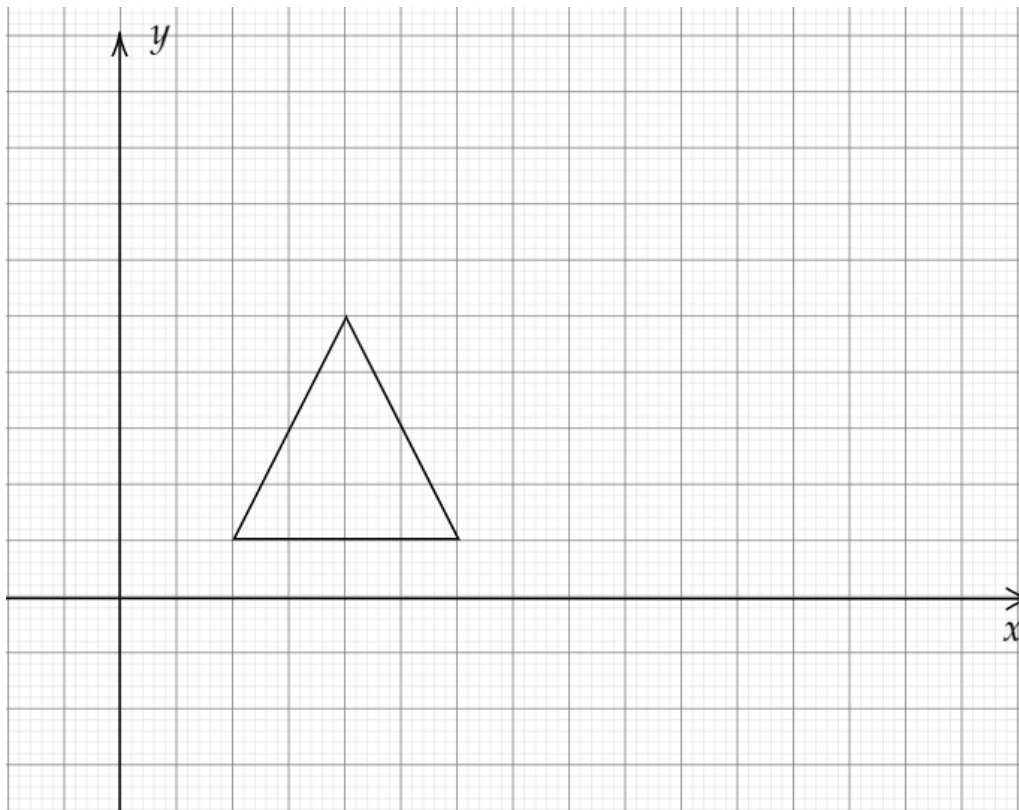

**Step 1:** Plot the point for the centre of enlargement.

**Step 2:** Choose an appropriate initial point to enlarge. Find the horizontal and vertical distance from this point to the centre of enlargement.

**Step 3:** Multiply the distances found by the scale factor.

**Step 4:** Use the vector found to find the image of the point chosen.

**Step 5:** Work out the final whole enlarged shape.



### Now it's your turn!

If you get stuck, look back at the worked and guided examples.

Each square in the grid is of length 1.

5. Consider the following graph with shape A and shape B.

Mark the centre of enlargement if shape B is enlarged to shape A. What is the scale factor for this enlargement?

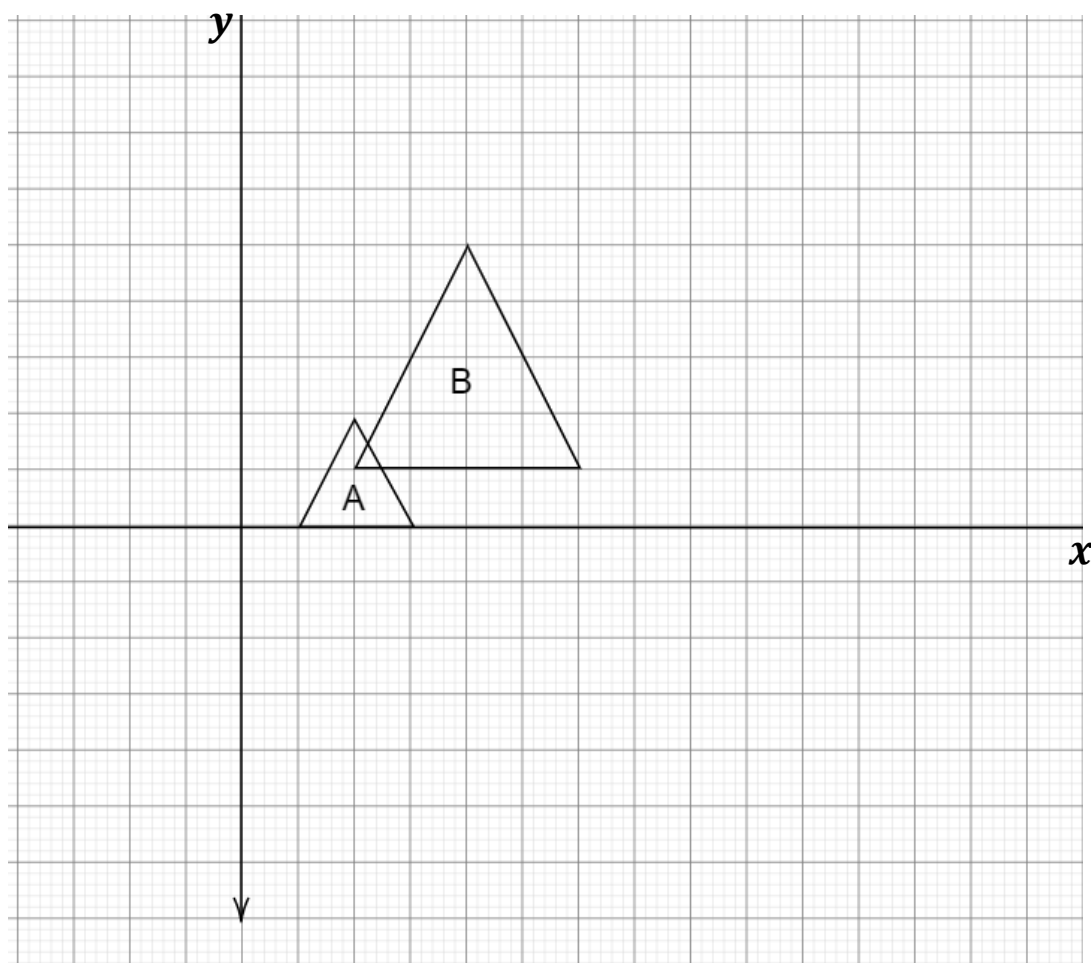

6. Consider shape A in the following grid.
- a) Enlarge shape A by a scale factor of 3, and name the new shape 'shape C'.
  - b) Enlarge shape A by a scale factor of  $\frac{1}{2}$ , and name the new shape 'shape D'.

Centre of enlargement for both the enlargements is (0,1).

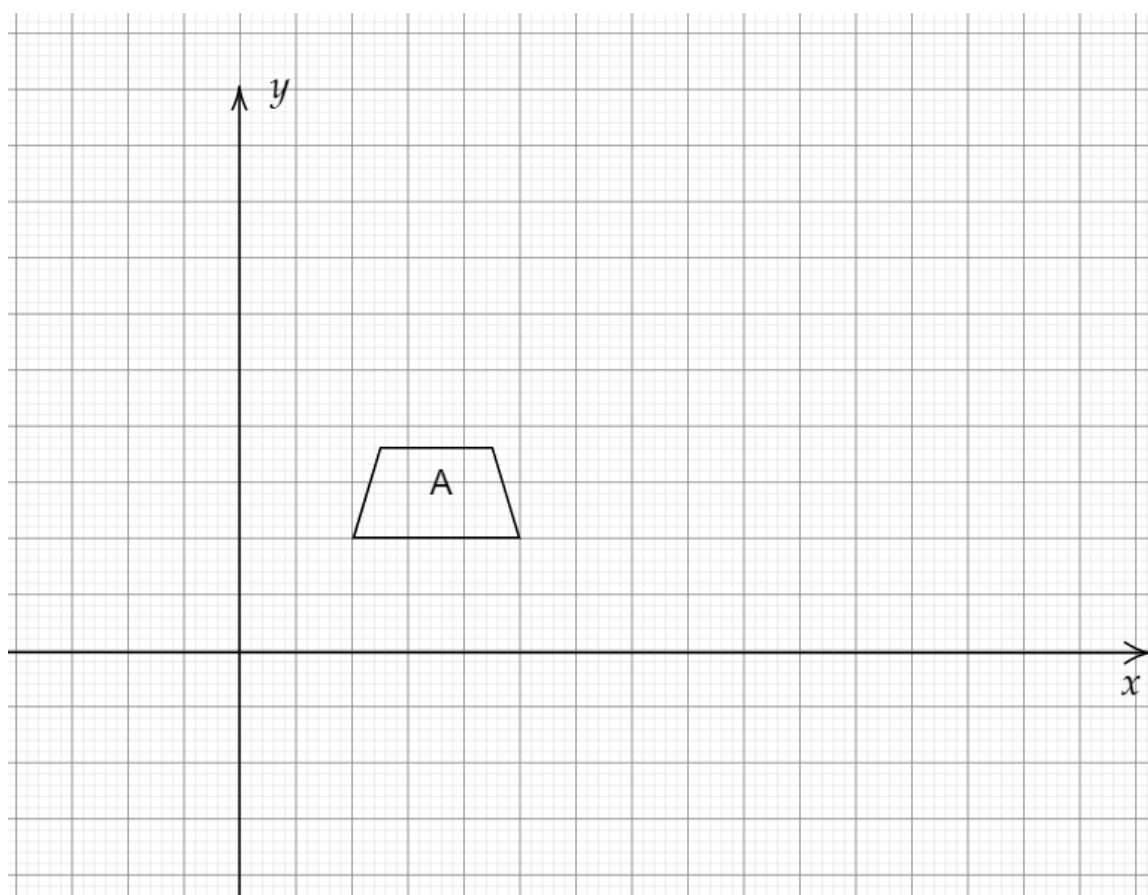



7. Enlarge the following shape by the scale factor 2 with centre of enlargement:

a) the origin

b) (5,4)

c) (-1, -1)

Label the new shapes as A, B and C, respectively.

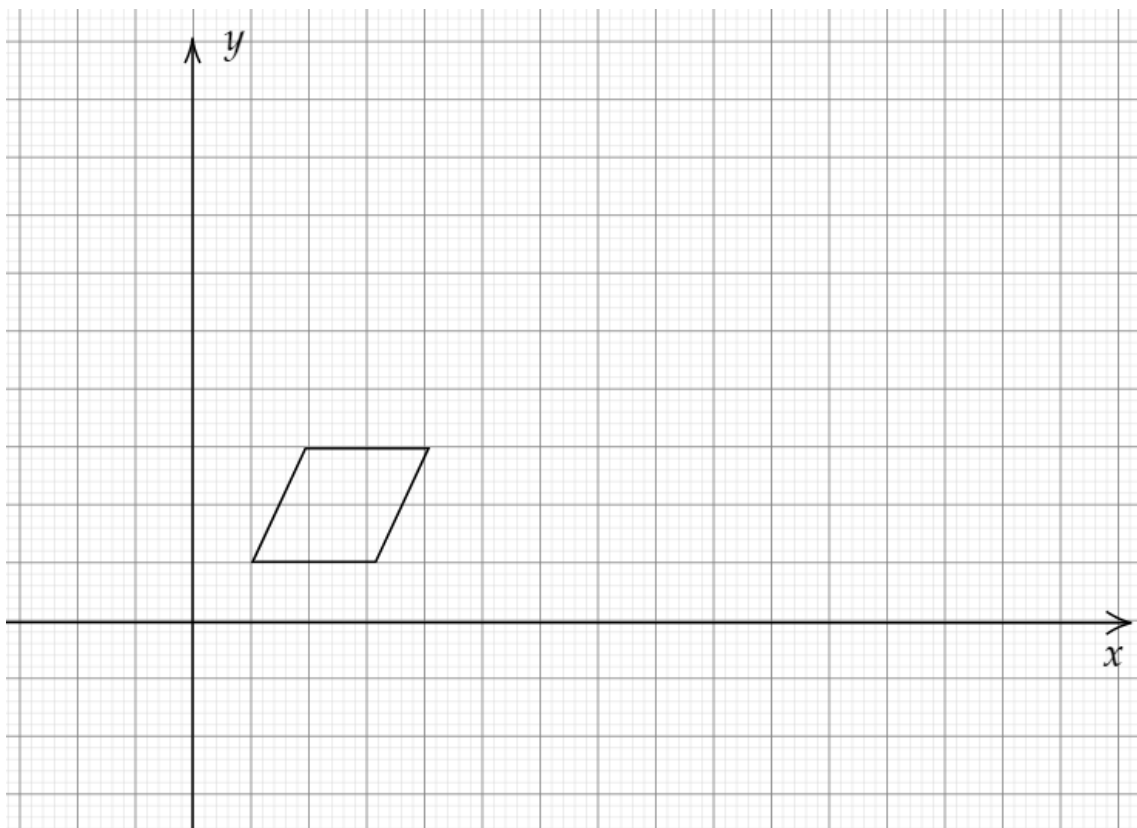

## Section D - Enlargement (Higher Only)

### Worked Example

Enlarge the following shape by scale factor  $-2$  and centre of enlargement  $(3, 2)$ .

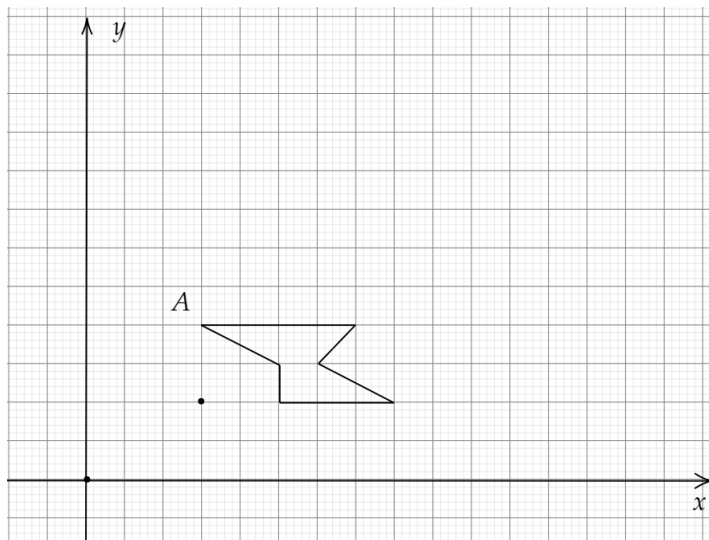

**Step 1:** Choose an appropriate initial point to enlarge. Find the horizontal and vertical distance from this point to the centre of enlargement.

*Point A has a vertical distance of 2 units from the centre of enlargement and a horizontal distance of 0 units from the centre of enlargement.*

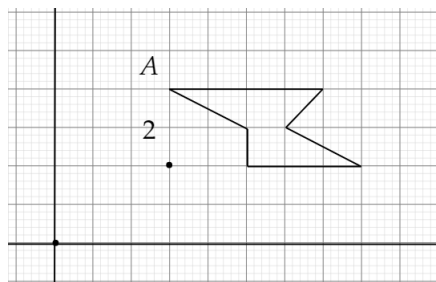

**Step 2:** Multiply the distances found by the scale factor.

*Scale factor =  $-2$*

*New vertical distance = Original vertical distance  $\times (-2) = 2 \times (-2) = -4$*

*New horizontal distance = Original horizontal distance  $\times (-2) = 0 \times (-2) = 0$*

**Step 3:** Use the vector found to find the image of the point chosen.

*The  $-4$  represents that A has moved negative 4 units in the downward direction from the centre of enlargement.*

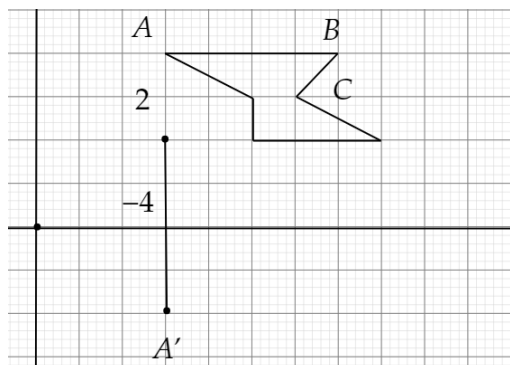

**Step 4:** Work out the final enlarged shape.

Length  $AB = 4$

So,

$$A'B' = AB \times (-2) = 4 \times (-2) = -8.$$

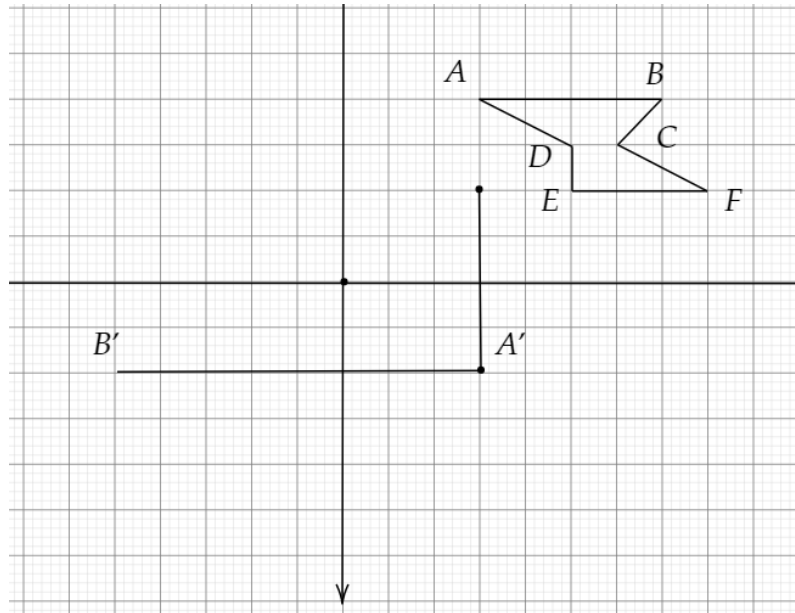

$EF$  is 2 away from the centre and has a length of 3:

$$2 \times (-2) = -4$$

$$E'F' \text{ length} = 3 \times (-2) = -6$$

$ED$  is length of 1:

$$E'D' \text{ length} = 1 \times (-2) = -2$$

$D'A'$  can be joined together.

$C$  and  $D$  have a difference of 1 so  $C'$  and  $D'$  will therefore have a difference of  $-2$ .

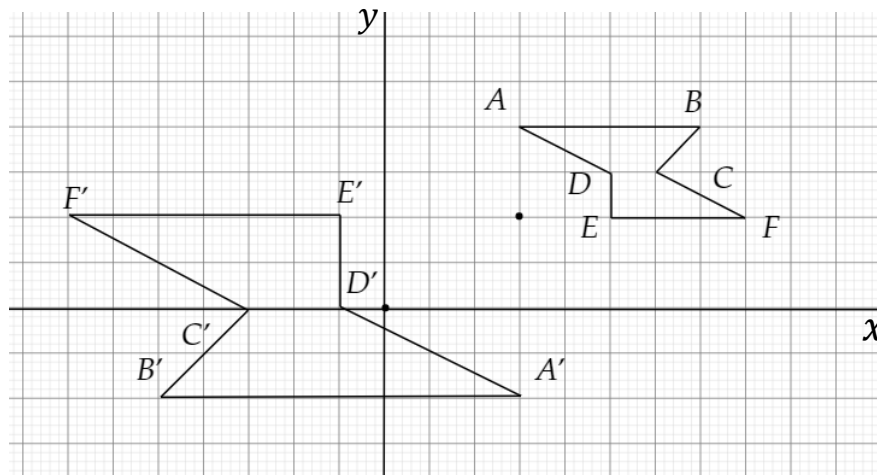

## Guided Example

Enlarge the following shape by a scale factor of  $-\frac{1}{2}$  with the centre of enlargement at  $(1, -2)$ . Each square in the grid is of length 1.

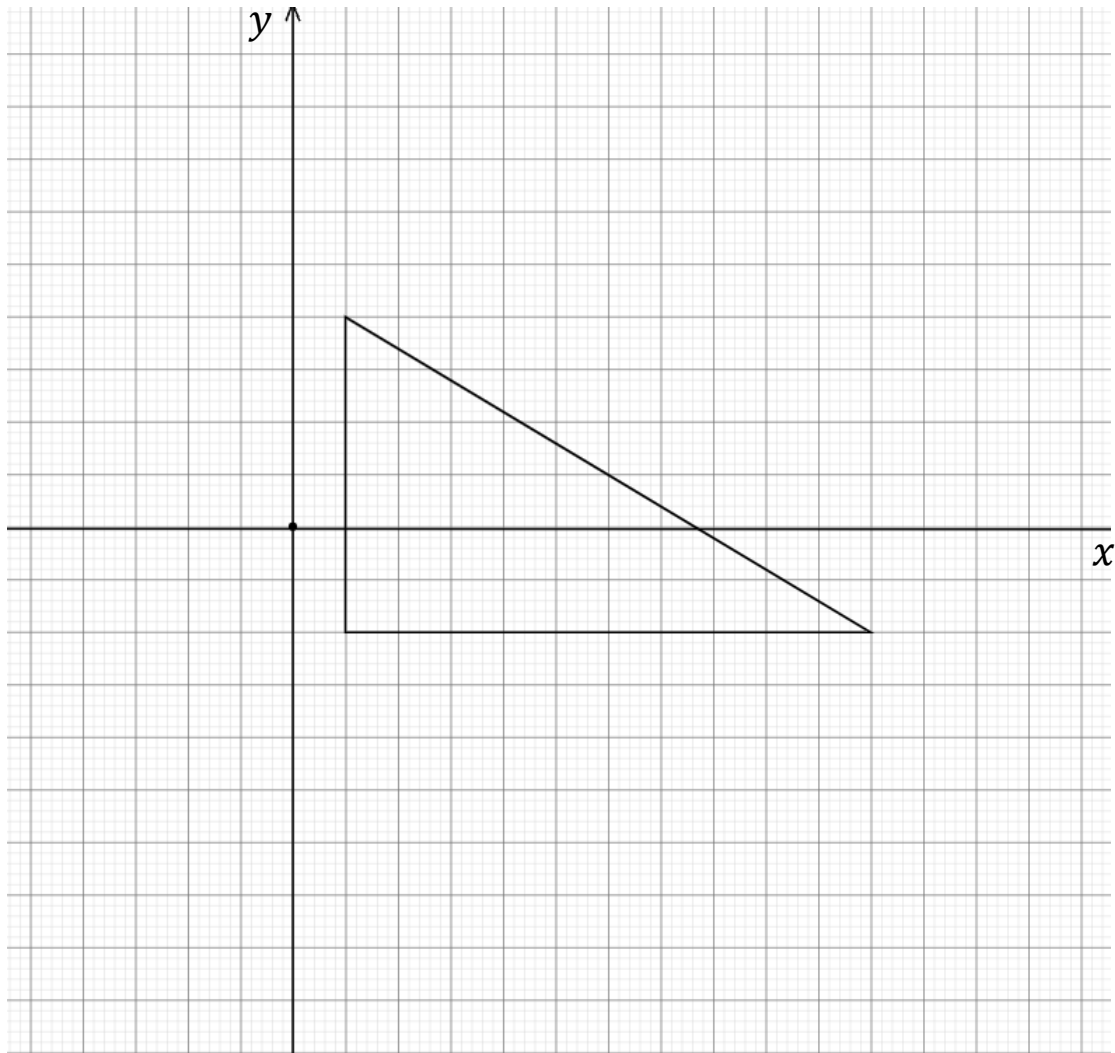

**Step 1:** Choose an appropriate initial point to enlarge. Find the horizontal and vertical distance from this point to the centre of enlargement.

**Step 2:** Multiply the distances found by the scale factor.

**Step 3:** Use the vector found to find the image of the point chosen.

**Step 4:** Work out the final whole enlarged shape.



### Now it's your turn!

If you get stuck, look back at the worked and guided examples.

Each square in the grid is of length 1.

8. Describe fully the transformation that transforms shape A to shape B.

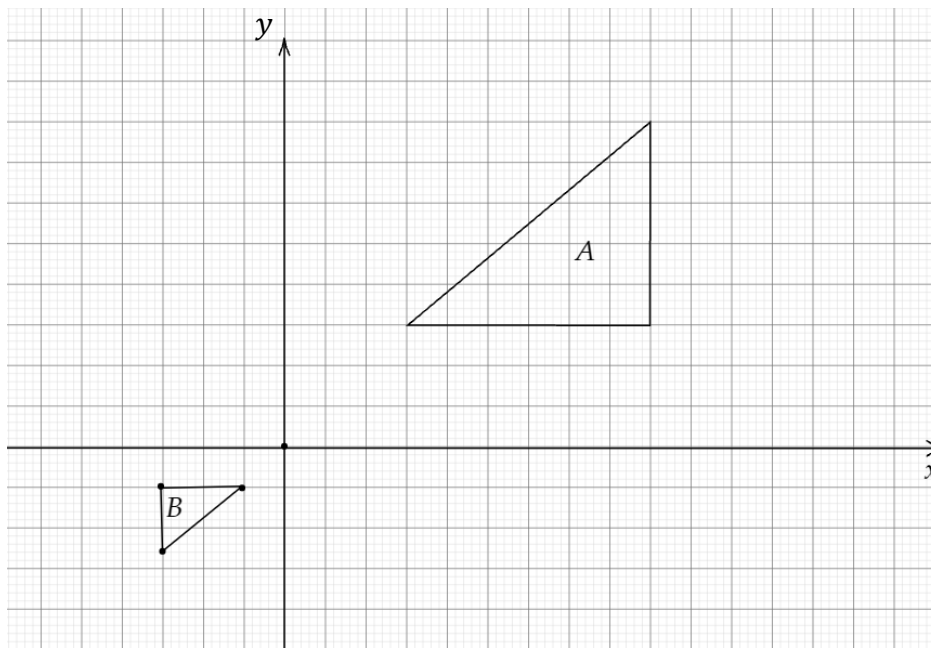

9. Enlarge the following shape by scale factor  $-2$  with centre of enlargement  $(1,1)$ .

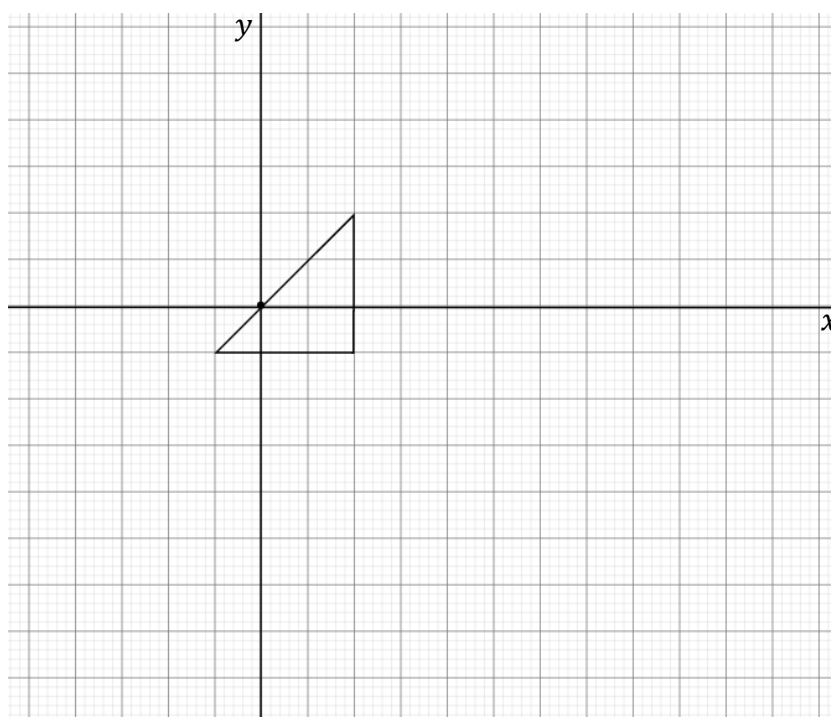

## Section E - Rotations

### Worked Example

Rotate the following shape  $90^\circ$  anti-clockwise with the origin as the centre of rotation.

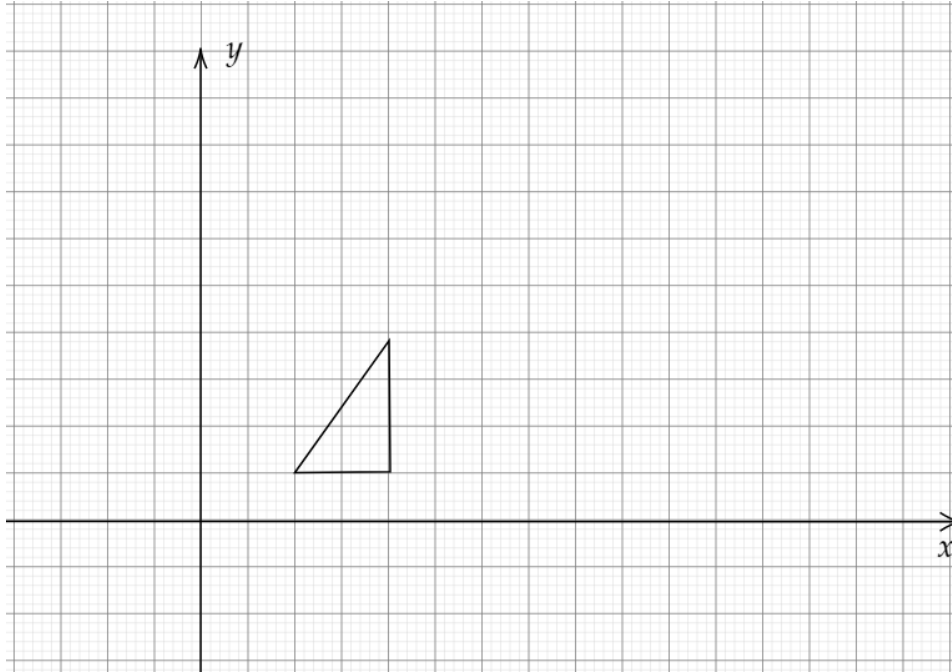

**Step 1:** Place tracing paper on the graph, trace the original shape and mark the centre of rotation.

*Using tracing paper will make the rotation much easier!*

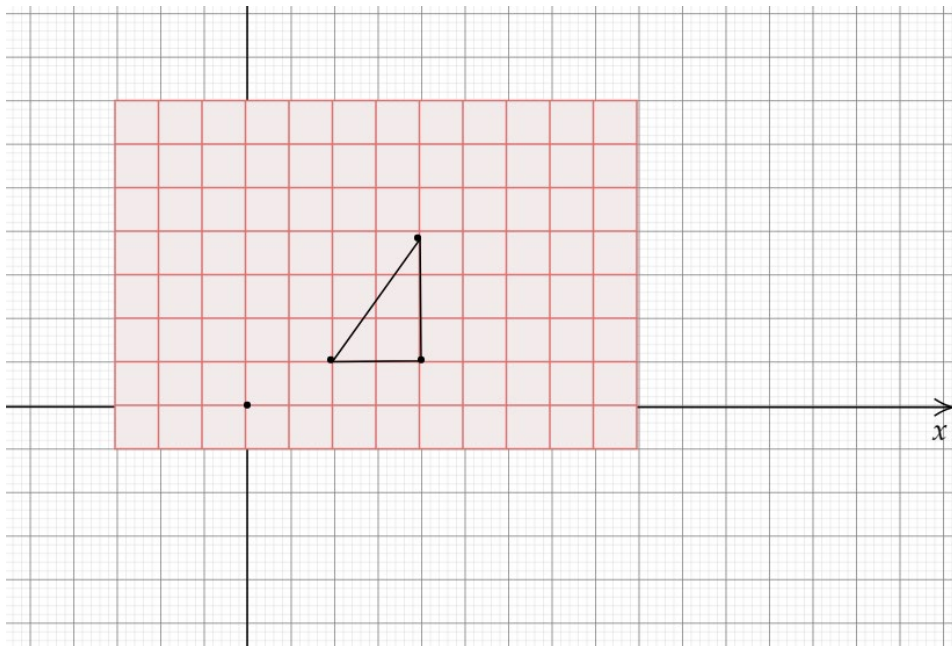

**Step 2:** Hold down the writing pen on the centre of rotation and rotate the tracing paper according to the rotation described in the question.

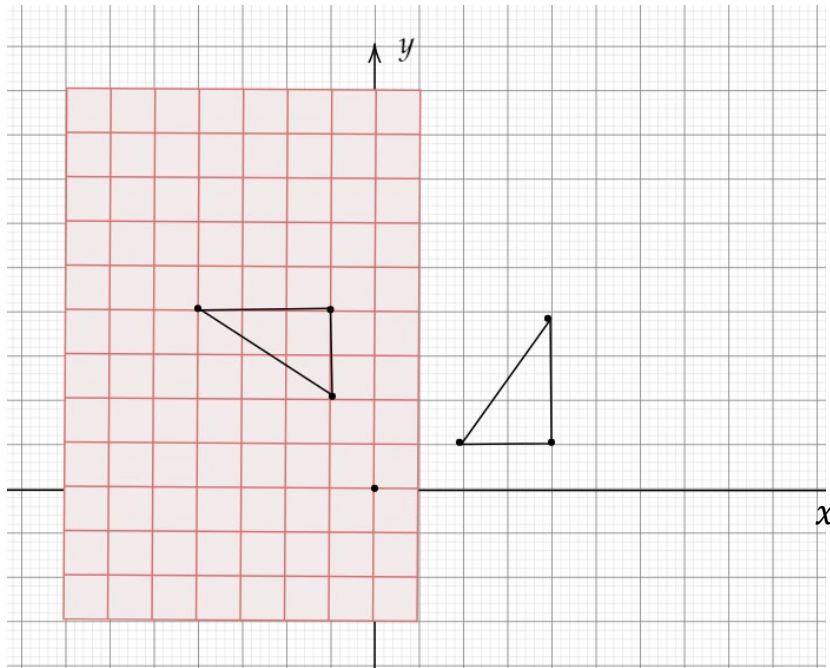

**Step 3:** Remove the tracing paper and draw the final image on the graph.

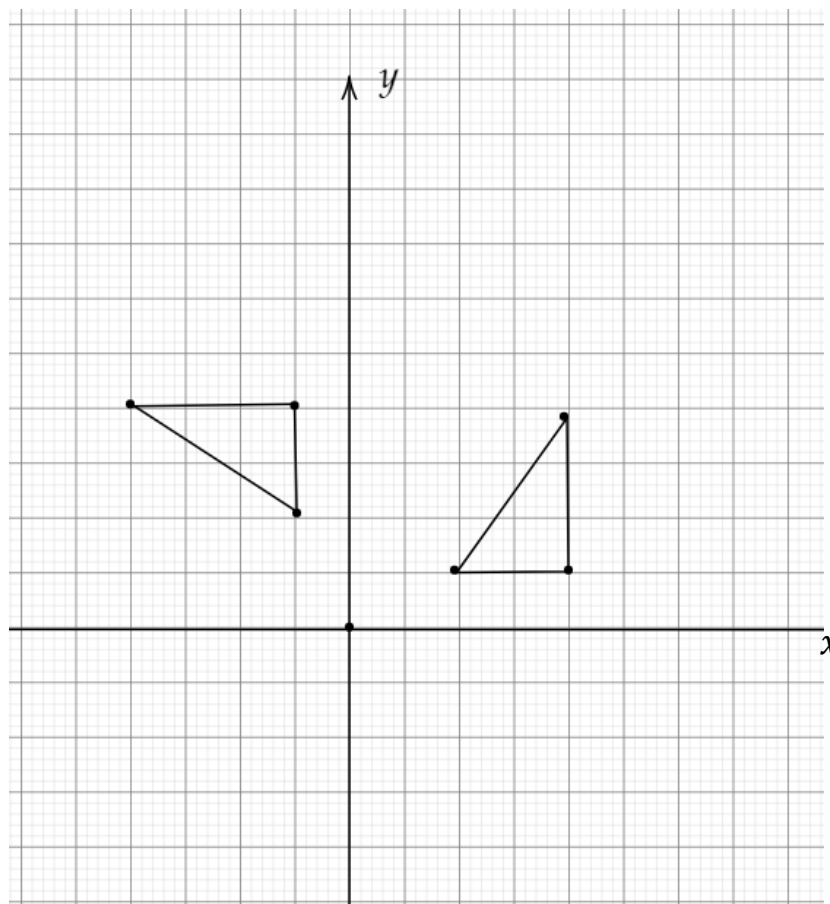

### Guided Example

Rotate the following shape  $180^\circ$  clockwise with the centre of rotation at  $(-1, -2)$ .

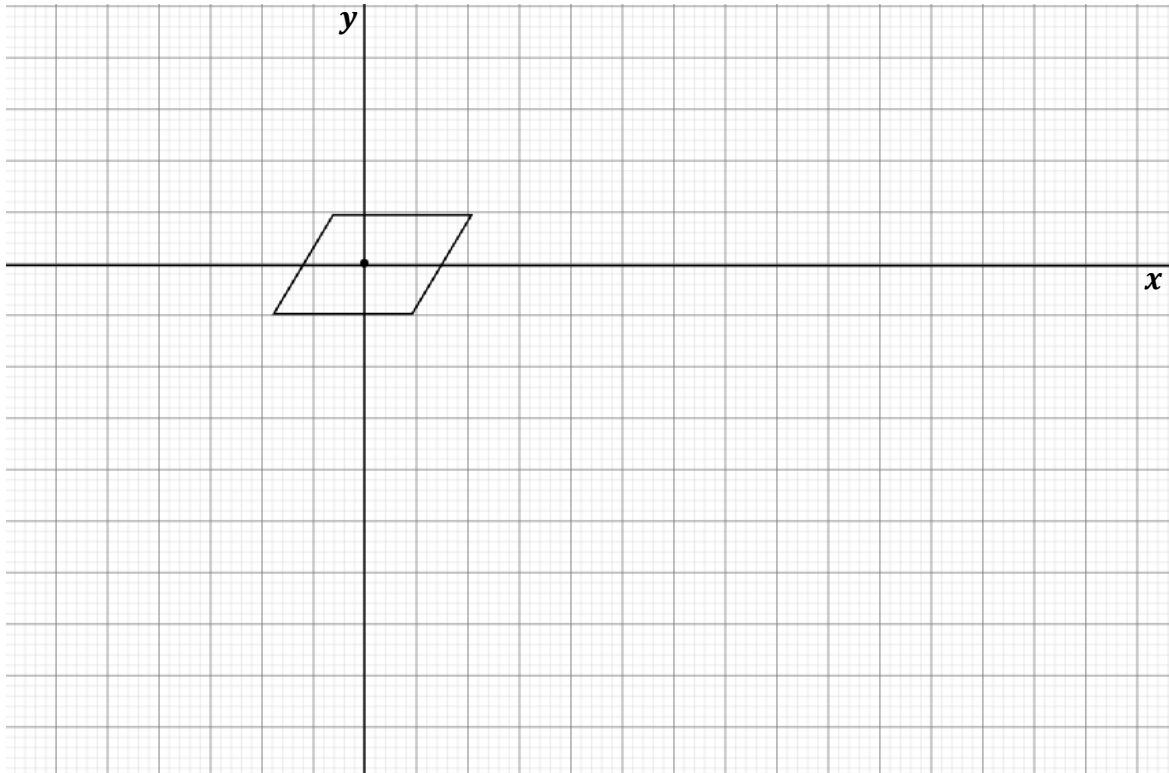

**Step 1:** Place tracing paper on the graph, trace the original shape and mark the centre of rotation.

**Step 2:** Hold down the writing pen on the centre of rotation and rotate the tracing paper according to the rotation described in the question.

**Step 3:** Remove the tracing paper and draw the final image on the graph.





### Now it's your turn!

If you get stuck, look back at the worked and guided examples.

Each square in the grid is of length 1.

10. Rotate the following shape by  $90^\circ$  clockwise with centre of rotation  $(2,2)$ .

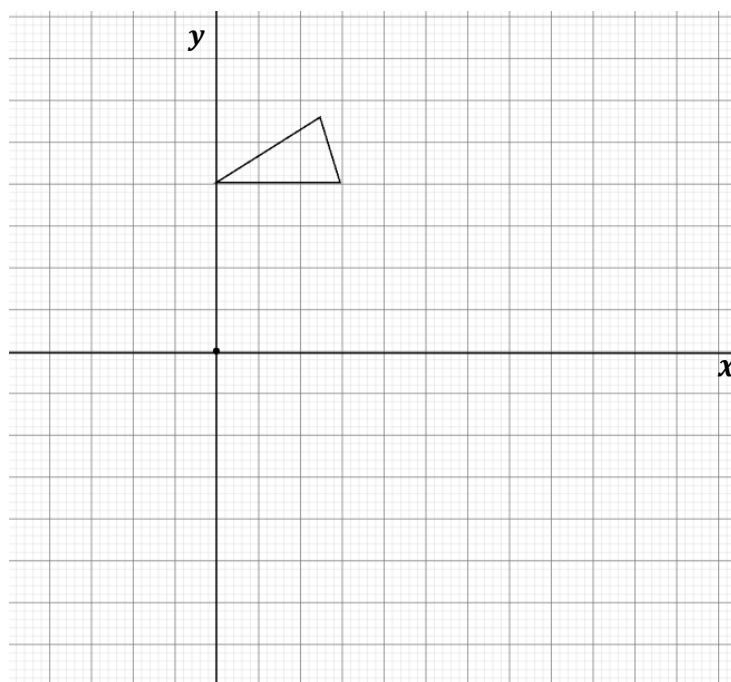

11. Rotate the following shape  $90^\circ$  anticlockwise with centre of rotation at the origin.

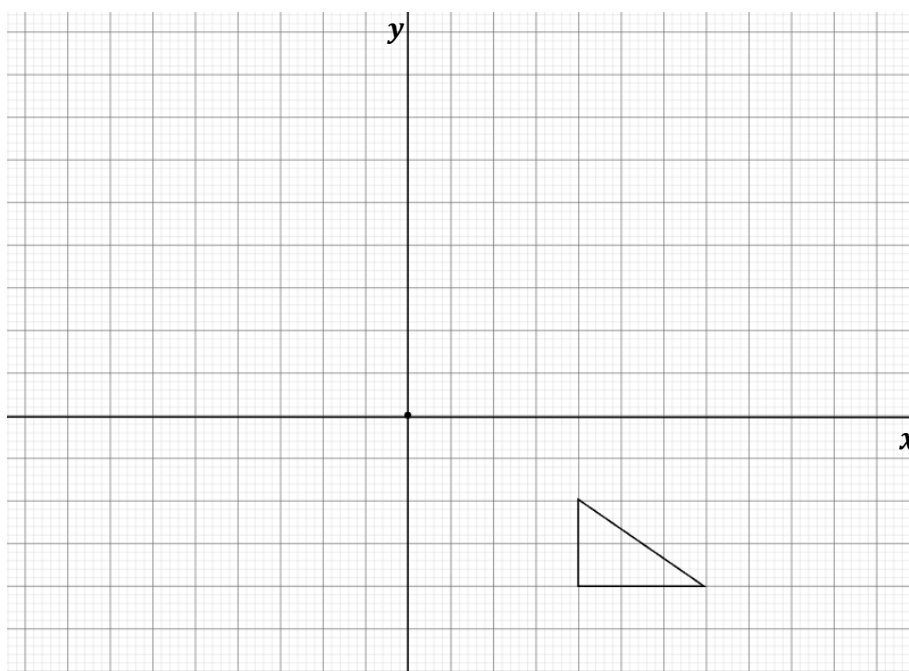

12. Consider the shape on the following grid.

- Rotate the following shape  $270^\circ$  anti-clockwise with centre of rotation  $(1, -2)$ . Label this shape B.
- Rotate shape B  $90^\circ$  clockwise around the same centre of rotation. Name this shape C.
- Describe the rotation which will map the initial shape to shape C.

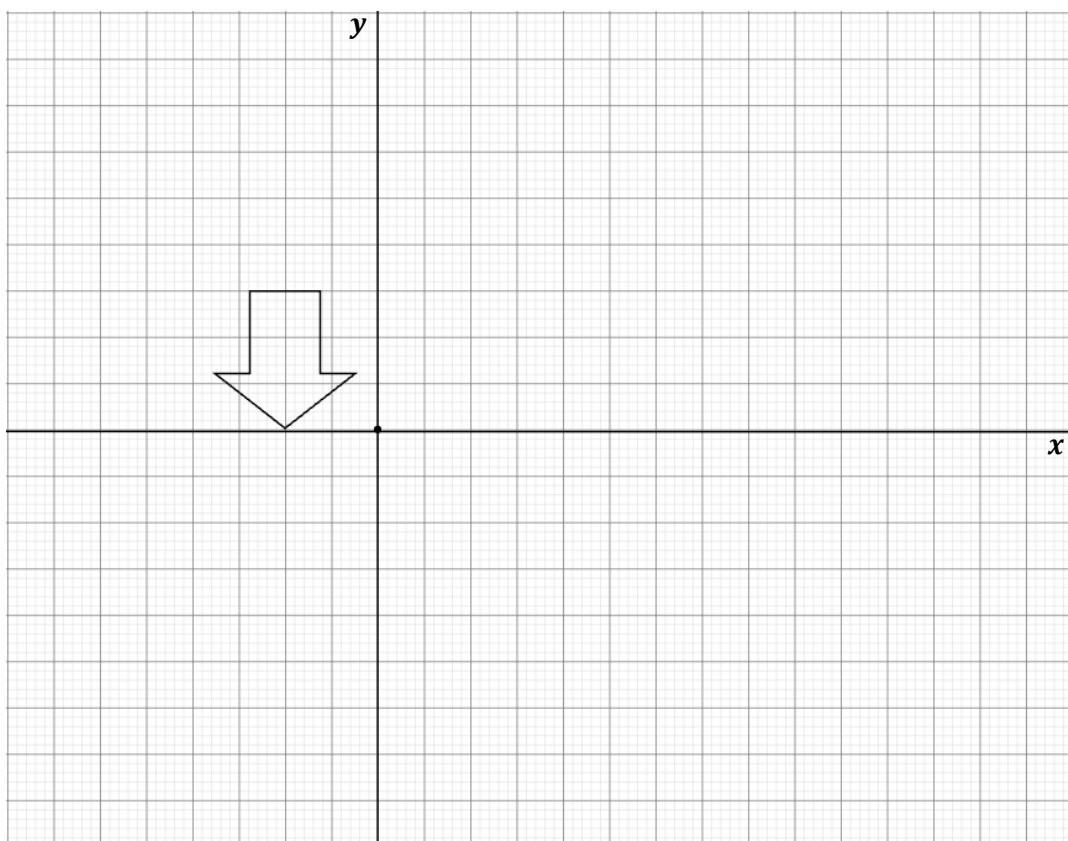

## Section F – Combined Transformations (Higher Only)

### Worked Example

Perform the following transformations to the shape below:

- Reflect the following shape in the line  $x = 1$ . Label the shape B.
- Reflect shape B in the line  $y = 3$ . Label this shape C.
- Rotate shape C about the origin clockwise  $180^\circ$ .

Explain if there are any invariant points between the transformations.

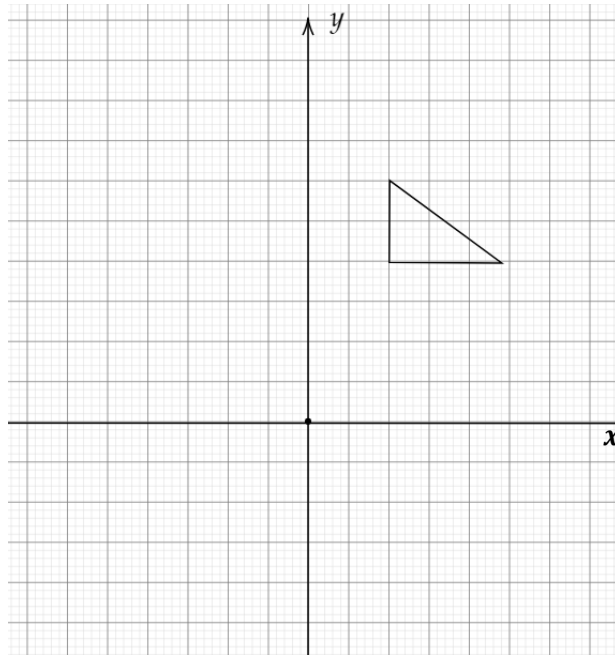

**Step 1:** Transformations need to be done in the order described.

*Reflection in the line  $x = 1$ :*

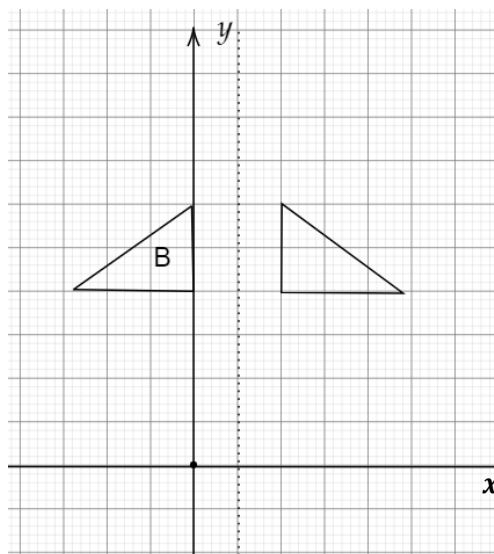

Reflection in the line  $y = 3$ :

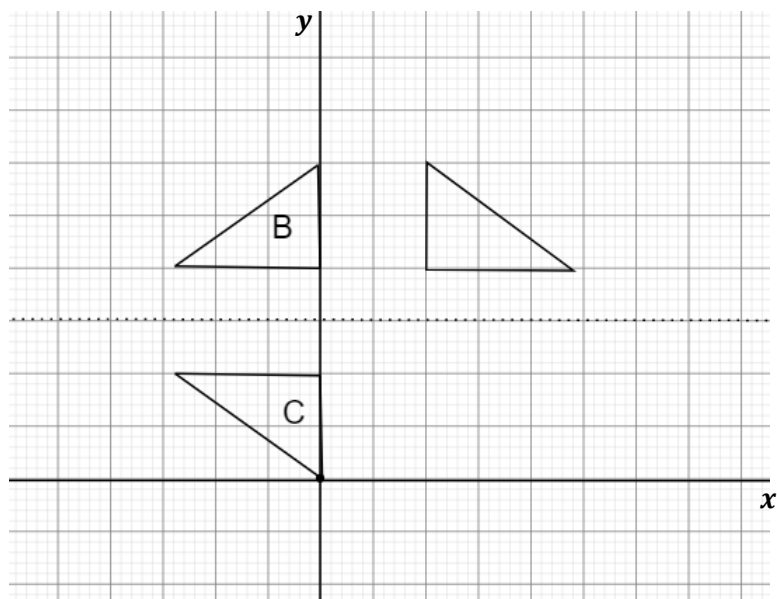

Rotation around the origin clockwise  $180^\circ$ :

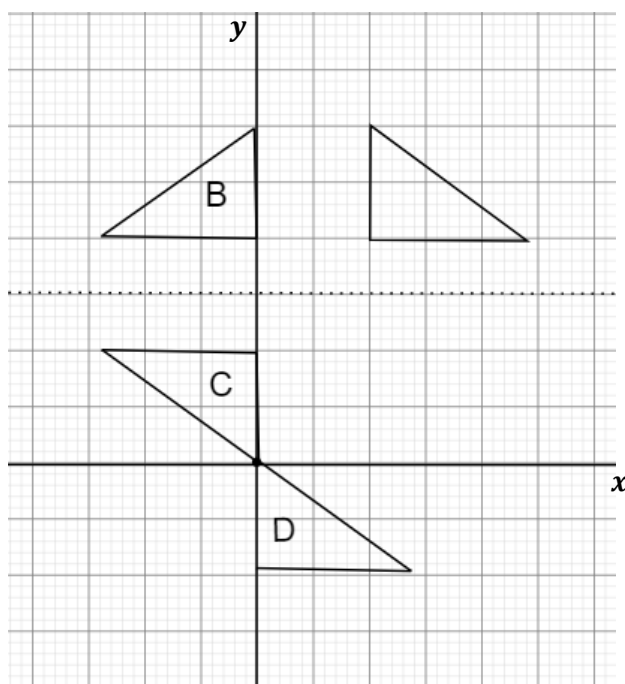

**Step 2:** Find and explain if any invariant points are present.

**Invariant points** are points which stay the same under a transformation.

The **origin** is an invariant point. This is because when transforming C to D through rotation, the point on the origin is fixed. It is at the same location for both the shape and the image.

There are no other invariant points throughout the transformations.



## Guided Example

Perform the following transformations to the shape below:

- Rotate the following shape  $180^\circ$  clockwise with centre of rotation  $(0, 2)$ . Label the shape B.
- Rotate B anti-clockwise  $180^\circ$  with centre of rotation  $(0, 3)$ . Label this shape C.

Find a transformation, that can transform the initial shape to shape C.

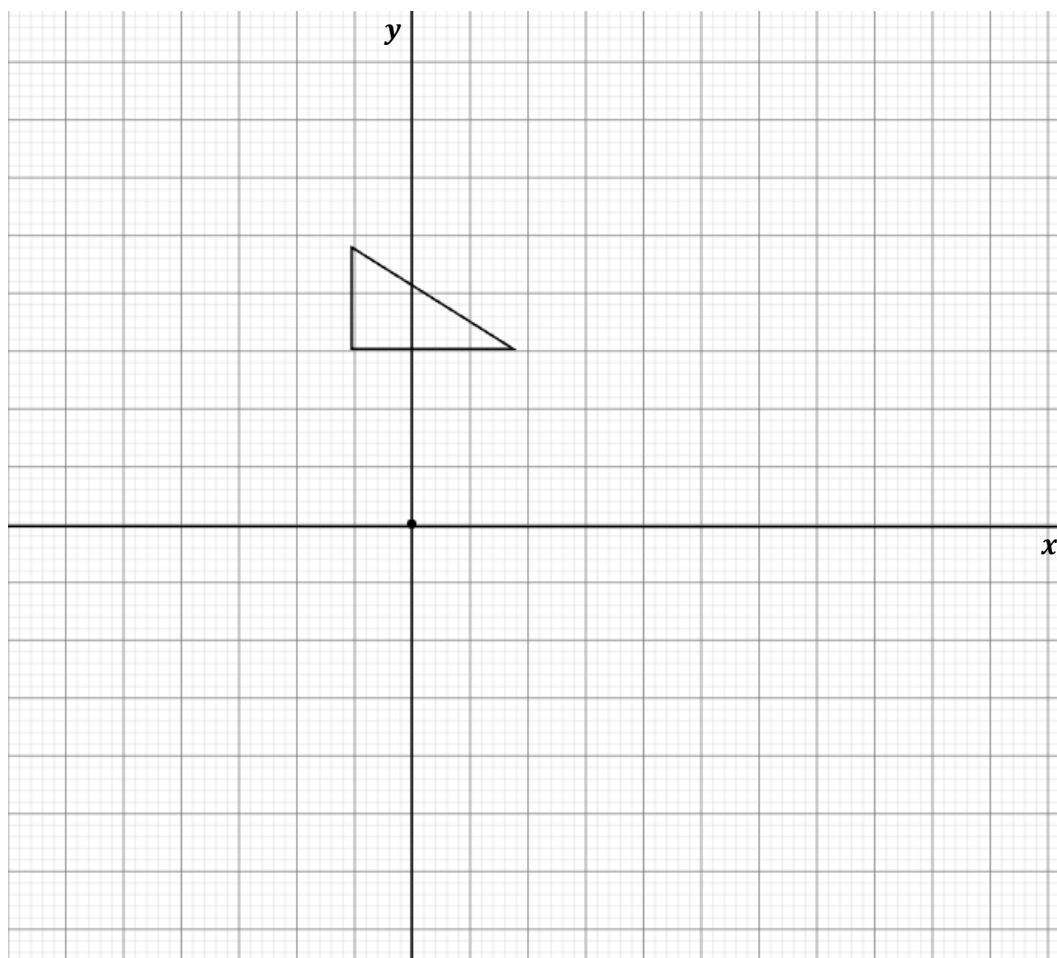

**Step 1:** Transformations need to be done in the order described.

**Step 2:** Find the final transformation which maps the initial shape to shape C.



### Now it's your turn!

If you get stuck, look back at the worked and guided examples.

Each square in the grid is of length 1.

13. Translate the following shape by the series of translations described:

- Reflect the following shape in the line  $x = 1$ . Label the shape B.
- Translate shape B by the vector  $\begin{pmatrix} 3 \\ 1 \end{pmatrix}$ . Label the new shape C.
- Rotate shape C  $270^\circ$  anticlockwise about the point  $(4, -2)$ . Label the new shape D.

Find and reason the presence of any invariant vertices from the initial shape to the final shape.

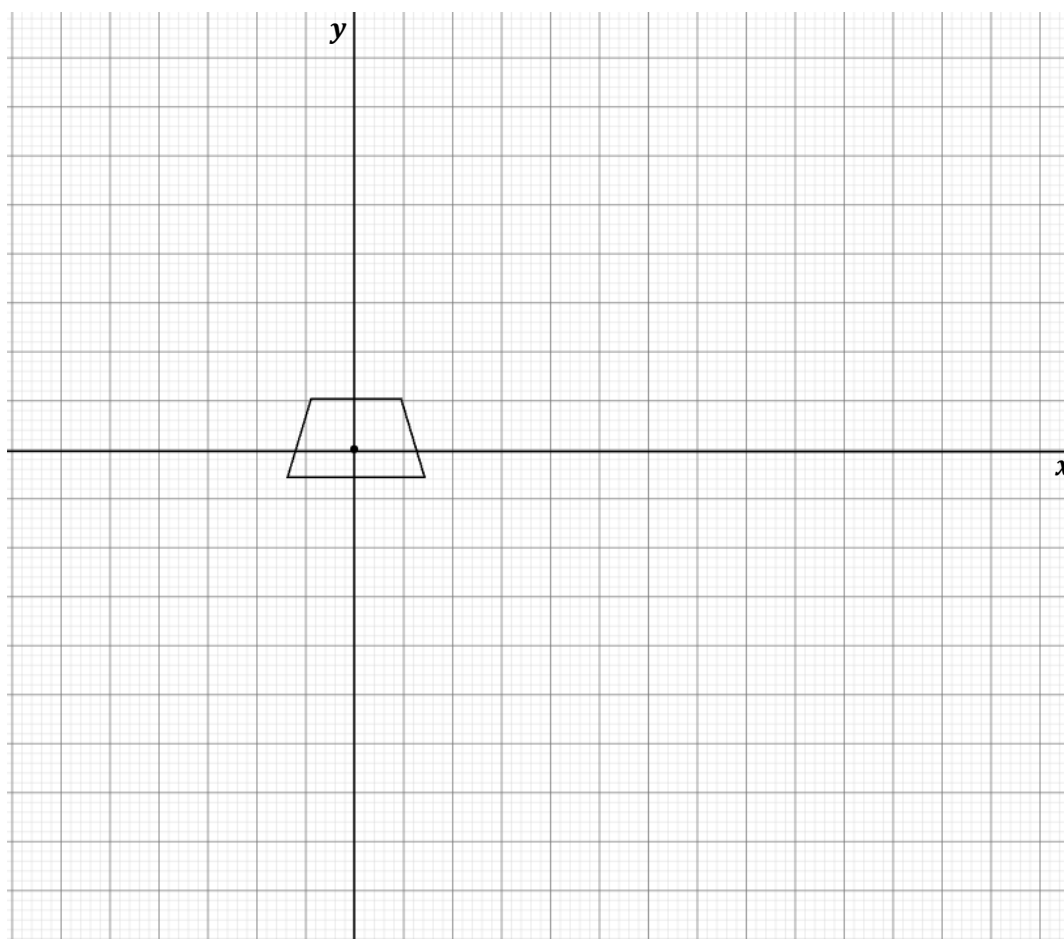

14. Shape A is reflected in the line  $y = 3$ , which is then reflected in the line  $x = 3$ .  
The final shape is labelled B.

Describe the single transformation that maps A to B.

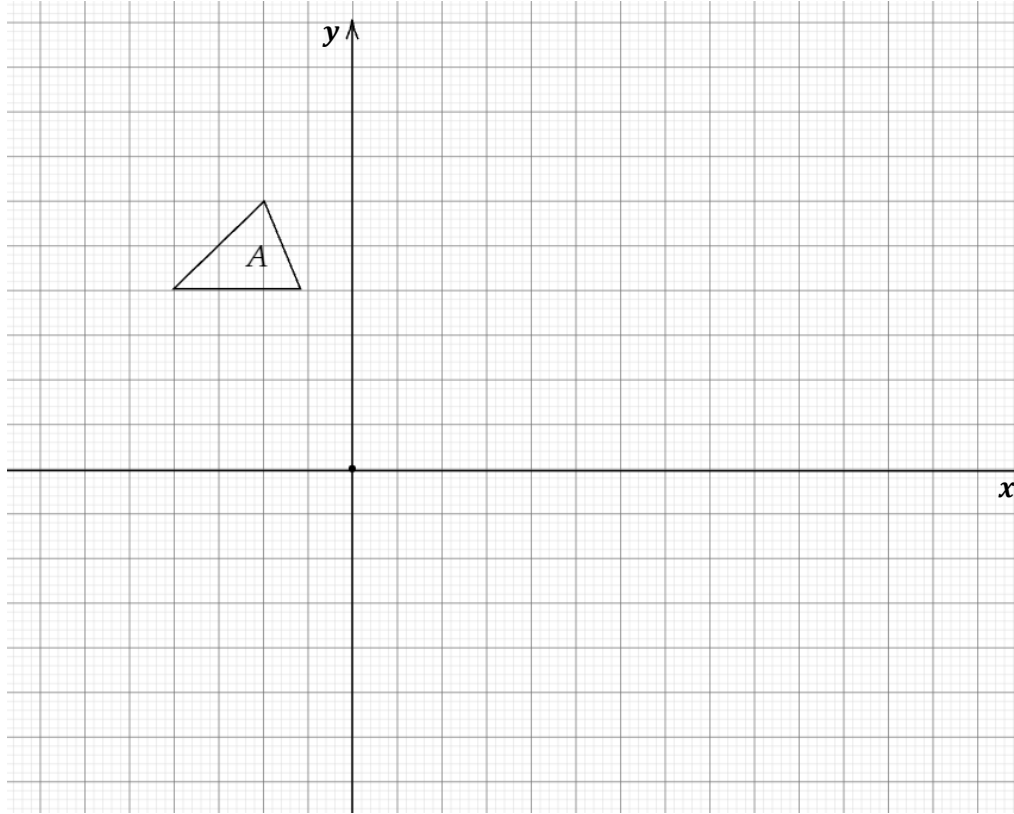

15. Describe transformations for the following shape, that would lead to 1 or more than 1 invariant vertices of the triangle. These are **not** combined transformations. One of each, rotation, enlargement, translation, and reflection.

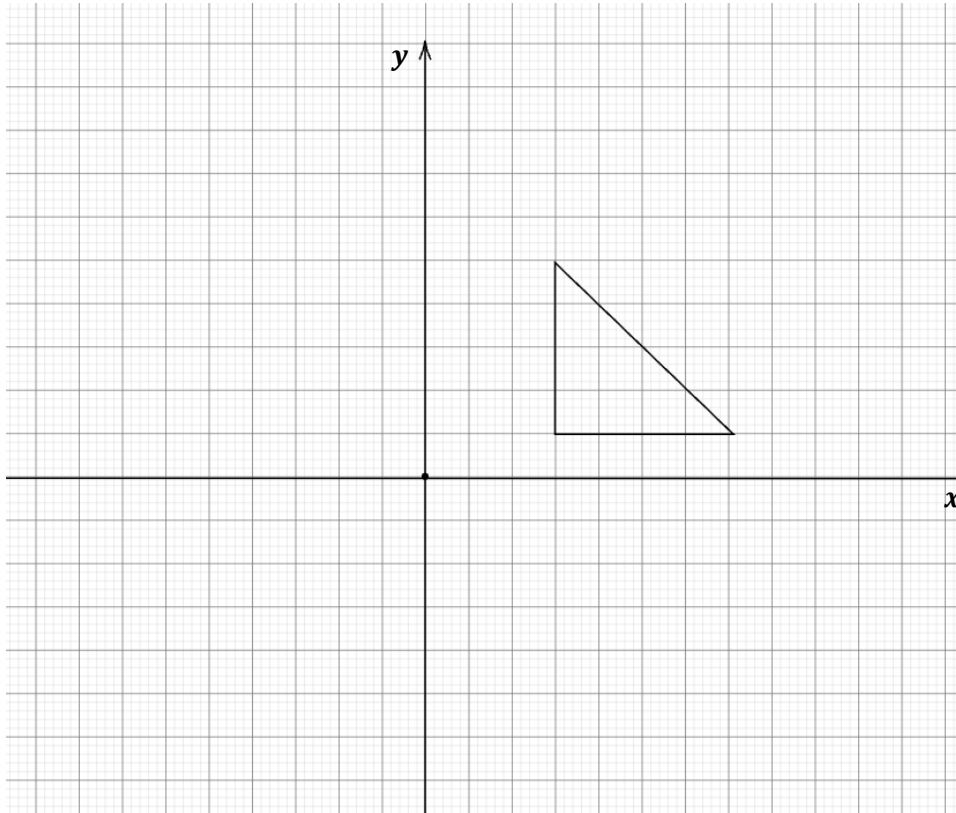



16. The following shape is rotated around the origin  $270^\circ$  clockwise and then reflected in the line  $x = y$ .

Describe the transformation that maps the initial image to the final image.  
Label any invariant points if present.

